

Overview

The VA-748x Series Electric Terminal Unit Valve Actuator provides floating, proportional, or proportional control with 0-10V position feedback signal and electric fail safe function in HVAC applications. The compact design of this actuator series makes it suitable for installation in confined locations, such as fan coils, chilled ceilings, manifolds, and more.

The VA-748x Series Actuator is designed for field mounting onto Johnson Controls and competitors' terminal unit valves. Due to the innovative concept of auto stroke detection, the VA-748x can be installed over most of the conventional terminal unit valves and pressure independent control valves (PICV) with variable strokes on the market.



Figure 1: VA-748x Series Electric Terminal Unit Actuator

Features

- **Low and line voltage** — Flexible applications
- **Floating and proportional control** — Flexible applications
- **Voltage and current analog input** — Suitable for any controller
- **Different analog input ranges** — Flexible applications
- **Different actuator speeds** — New market opportunities
- **Double and RGB colour LED** — Provide information about status and diagnostic
- **Removable cable** — No expert required for connection or replacement
- **Different cable length available as separate kit** — OEM's version easily available
- **Auto stroke detection** — Suitable for valve with variable stroke
- **Feedback control** — 0-10 VDC with max. 2mA output current
- **Electrical fail safe** — Protects the equipment and the system from damage, while enhancing overall efficiency

■ Ordering codes

Product codes	Control type	Power supply	Running time	Nominal force	Factory stroke config.	Cable length	Mounting thread nut	Special config.	Feedback	Electrical fail safe	Enclosure			
VA-7480-0011	Floating	24 VAC	13 sec/mm	120 N	---	1.5 m	M28x1.5	---	---	---	IP54			
VA-7480-0312			8 sec/mm			3 m		UL Listed						
VA-7481-0011			13 sec/mm			1.5 m	---							
VA-7480-0001			8 sec/mm											
VA-7481-0001			13 sec/mm	2 m		M30x1.5	---							
VA-7480-0201-TA				5 m										
VA-7480-0501-TA				230 VAC				120 N				1.5 m	M28x1.5	
VA-7480-4001		8 sec/mm												
VA-7480-4003		13 sec/mm												
VA-7480-0013		8 sec/mm	M30x1.5			---								
VA-7481-0013		13 sec/mm												
VA-7480-0003		8 sec/mm												
VA-7481-0003		8 sec/mm												
VA-7481-4003														
VA-7482-1001	Proportional	24 VAC/ VDC	8 sec/mm	120 N	3.2 mm	1.5 m	M30x1.5	---	---	---	IP54			
VA-7482-2001					4.3 mm									
VA-7482-3001					6.0 mm									
VA-7482-1001-RA					3.2 mm	3 m						Reverse action		
VA-7482-1301-RA					4.3 mm									
VA-7482-2001-RA					---	3 m						M28x1.5	---	
VA-7482-0011							UL Listed							
VA-7482-0311														
VA-7482-0312					140 N	4.3 mm	2 m	Reverse action						
VA-7482-2201-TA							5 m							
VA-7482-2501-TA							120 N					1.5 m	---	
VA-7482-5001					2.5 mm									
VA-7482-6001				5 mm										
VA-7482-7001				5.5 mm	2 m halogen free	M30x1.5	Reverse action and UL listed							
VA-7482-8201				160 N				Auto stroke detection				2 m halogen free	---	
VA-7482-9201														1.5 m CMP
VA-7482-8201-RA														
VA-7482-9201-RA				2 m halogen free				Reverse action						
VA-7482-8002-RA												1.5 m halogen free	Reverse action	
VA-7482-9002-RA				---	---									
VA-7482-8302-RA						Reverse action	---							
VA-7483-8201				1.5 m halogen free	Reverse action									
VA-7483-9201						---	---							
VA-7483-8201-RA				Reverse action	---									
VA-7483-9201-RA						---	---							
VA-7484-8001				1.5 m halogen free	Reverse action									
VA-7484-9001						---	---							
VA-7484-8001-RA				Reverse action	---									
VA-7484-9001-RA						---	---							
VA-7484-8001-RA				Reverse action	---									
VA-7484-9001-RA	---	---												

■ Accessories (order separately)

Accessories codes	Description	Packing
VA-7480-CAB21	Floating 24V – 2 m length	Plastic Bag
VA-7480-CAB31	Floating 24V – 3 m length	
VA-7480-CAB51	Floating 24V – 5 m length	
VA-7480-CAB11	Floating 24V – 10 m length	
VA-7480-CAB33	Floating 230V – 3 m length	
VA-7480-CAB53	Floating 230V – 5 m length	
VA-7480-CAB73	Floating 230V – 7 m length	
VA-7480-CAB13	Floating 230V – 10 m length	
VA-7482-CAB21	Proportional 24V – 2 m length	
VA-7482-CAB31	Proportional 24V – 3 m length	
VA-7482-CAB51	Proportional 24V – 5 m length	
VA-7482-CAB71-HF	Proportional 24V – 7 m length - Halogen free	
VA-7482-CAB21-HF	Proportional 24V – 2 m length - Halogen free	
VA-7482CAB7452	Cable kit to replace VA-7452 with VA-7482	Single pack
VA-748X-CONF	Configuration tool	

■ Valve compatibility (1/2)

Actuator codes	Johnson Controls	Danfoss	Frese	Industrie Technik	Oventrop	Sauter	Schneider Electric	Siemens	TA Hydraulics	Fratelli Pettinaroli	Watts Industries	Controlli
VA-7480-0011	VG4000 Series (discontinued) VG5000 Series (discontinued)	---	---	---	---	---	---	---	---	---	---	---
VA-7480-0312												
VA-7481-0011												
VA-7480-0013												
VA-7481-0013												
VA-7482-0011												
VA-7482-0311												
VA-7482-0312												
VA-7480-0001	VG3000 Series V5000 Series (discontinued) VG6000 Series (discontinued) VP1000 Series	AB-QM (DN15-DN32)	---	VFX (DN15-DN20)	COCON QTZ (DN10-DN32) COCON 2TZ (DN15-DN20) Tri-M Plus (DN15)	VUL Series BUL Series VUT Series BUT Series VXL Series BXL Series VCL (DN10-DN32)	VZx8 Series VZx8C (DN15-DN20)	VVP47 Series VXP47 Series VMP47 Series VVI46 Series VXI46 Series VVS46 Series VXS46 Series	TA Compact (DN10-DN32) TA Modulator (DN15-DN20)	91 Series 92 Series 93 Series	2131 Series 3131 Series 4131 Series	---
VA-7481-0001												
VA-7480-0003												
VA-7481-0003												
VA-7482-1001 VA-7482-1001-RA VA-7482-1301-RA	VP1000 (DN15-DN20) VG6000 Series (discontinued)	AB-QM (DN10-DN20)	---	VFX Series (DN15-DN20)	COCON QTZ (DN10-DN15)	VUT Series BUT Series VXL Series BXL Series VCL (DN10-DN15)	VZx8 Series VZx8C (DN15-DN20)	VVP47 Series VXP47 Series VMP47 Series VVI46 Series VXI46 Series VVS46 Series VXS46 Series	---	91 Series	2131 Series 3131 Series 4131 Series	---
VA-7482-2001 VA-7482-2001-RA	VG3000 Series V5000 Series (discontinued)	---	---	---	COCON QTZ (DN20-DN32) COCON 2TZ (DN15-DN20) Tri-M Plus (DN15)	VUL Series BUL Series VCL (DN20-DN32)	---	---	---	---	---	---
VA-7482-3001	VP1000 (DN25-DN32)	AB-QM (DN25-DN32)	---	---	---	---	---	---	---	93 Series	---	---
VA-7480-0201-TA VA-7480-0501-TA	---	---	---	---	---	---	---	---	TBV-C (DN15-DN25) TBV-CM (DN15-DN25) TBV-CMP (DN15-DN25) KTCM512 (DN15-DN25)	---	---	---
VA-7482-2201-TA VA-7482-2501-TA	---	---	---	---	---	---	---	---	TBV-C (DN15-DN20) TBV-CM (DN15-DN25) TBV-CMP (DN15-DN25) KTCM512 (DN15-DN25)	---	---	---

Valve compatibility (2/2)

Actuator codes	Johnson Controls	Danfoss	Frese	Industrie Technik	Oventrop	Sauter	Schneider Electric	Siemens	TA Hydraulics	Fratelli Pettinaroli	Watts Industries	Controlli
VA-7480-4001	---	---	Optima Compact 53-13xx (DN10-DN32)	---	---	---	---	---	---	---	---	VSX0xPB
VA-7480-4003												VSXT0xPB (DN10-DN32)
VA-7481-4003												
VA-7482-5001	---	---	Optima Compact 53-13xx 2,5 mm (DN10-DN20)	---	---	---	---	---	---	---	---	VSX03PB VSX04PB VSX05PB VSX06PB (DN10-DN20)
VA-7482-6001	---	---	Optima Compact 53-13xx 5,0 mm (DN10-DN20)	---	---	---	---	---	---	---	---	VSXT03PB VSXT04PB VSXT06PB (DN10-DN20)
VA-7482-7001	---	---	Optima Compact 53-13xx 5,5 mm (DN25-DN32)	---	---	---	---	---	---	---	---	VSXT07PB VSX08PB (DN25-DN32)
VA-7482-8201 VA-7482-8201-RA VA-7482-8002-RA VA-7482-8302-RA	VG3000 Series V5000 Series (discontinued) VG6000 Series (discontinued) VP1000 Series	AB-QM (DN10-DN32)	---	VFX Series (DN15-DN20)	COCON QTZ (DN10-DN32) COCON 2TZ (DN15-DN20) Tri-M Plus (DN15)	VUT Series BUT Series VXL Series BXL Series VCL (DN10-DN32) VUL Series BUL Series	VZx8 Series VZx8C (DN15-DN20)	VVP47 Series VXP47 Series VMP47 Series VVI46 Series VXI46 Series VVS46 Series VXS46 Series	TBV-C (DN15-DN20) TBV-CM (DN15-DN25) TBV-CMP (DN15-DN25) KTCM512 (DN15-DN25) TA Compact (DN10-DN32) TA Modulator (DN15-DN20)	91 Series 92 Series 93 Series	2131 Series 3131 Series 4131 Series	---
VA-7482-9201 VA-7482-9201-RA VA-7482-9002-RA	---	---	Optima Compact 53-13xx 2,5 mm (DN10-DN20) Optima Compact 53-13xx 5,0 mm (DN10-DN20) Optima Compact 53-13xx 5,5 mm (DN25-DN32)	---	---	---	---	---	---	---	---	VSX03PB VSX04PB VSX05PB VSX06PB (DN10-DN20) VSXT03PB VSXT04PB VSXT06PB (DN10-DN20) VSXT07PB VSX08PB (DN25-DN32)
VA-7483-8201 VA-7483-8201-RA VA-7484-8001 VA-7484-8001-RA	VG3000 Series V5000 Series (discontinued) VG6000 Series (discontinued) VP1000 Series	AB-QM (DN10-DN32)	---	VFX Series (DN15-DN20)	COCON QTZ (DN10-DN32) COCON 2TZ (DN15-DN20) Tri-M Plus (DN15)	VUT Series BUT Series VXL Series BXL Series VCL (DN10-DN32) VUL Series BUL Series	VZx8 Series VZx8C (DN15-DN20)	VVP47 Series VXP47 Series VMP47 Series VVI46 Series VXI46 Series VVS46 Series VXS46 Series	TBV-C (DN15-DN20) TBV-CM (DN15-DN25) TBV-CMP (DN15-DN25) KTCM512 (DN15-DN25) TA Compact (DN10-DN32) TA Modulator (DN15-DN20)	91 Series 92 Series 93 Series	2131 Series 3131 Series 4131 Series	---
VA-7483-9201 VA-7483-9201-RA VA-7484-9001 VA-7484-9001-RA	---	---	Optima Compact 53-13xx 2,5 mm (DN10-DN20) Optima Compact 53-13xx 5,0 mm (DN10-DN20) Optima Compact 53-13xx 5,5 mm (DN25-DN32)	---	---	---	---	---	---	---	---	VSX03PB VSX04PB VSX05PB VSX06PB (DN10-DN20) VSXT03PB VSXT04PB VSXT06PB (DN10-DN20) VSXT07PB VSX08PB (DN25-DN32)

Operation

24 VAC Floating Model

When the signal is applied to the black and red wires, the actuator stem extends. When the signal is removed the actuator remains in position. If the signal remains applied to the red wire, the actuator will time out and shut off the motor after approximately 90 seconds (13 sec/mm models) and approximately 60 seconds (8 sec/mm models).

When the signal is applied to the black and orange wires, the actuator stem retracts. When the signal is removed the actuator remains in position. If the signal remains applied to the orange wire, the actuator will time out and shut off the motor after approximately 90 seconds (13 sec/mm models) and approximately 60 seconds (8 sec/mm models).

End of stroke confirmation

When the signal is applied in the same direction, the actuator turns on every 2 hours and drives in the signal direction for approximately 90 seconds (13 sec/mm models) and approximately 60 seconds (8 sec/mm models) to confirm the end of stroke position.

Table 1: Actuator stem direction

Input	Direction	
Red wire energised	↓	Actuator stem extends
Orange wire energised	↑	Actuator stem retracts

230 VAC Floating Model

When the signal is applied to the blue and brown wires, the actuator stem extends. When the signal is removed the actuator remains in position. If the signal remains applied to the brown wire, the actuator will time out and shut off the motor after approximately 90 seconds (13 sec/mm models) and approximately 60 seconds (8 sec/mm models).

When the signal is applied to the blue and orange wires, the actuator stem retracts. When the signal is removed the actuator remains in position. If the signal remains applied to the orange wire, the actuator will time out and shut off the motor after approximately 90 seconds (13 sec/mm models) and approximately 60 seconds (8 sec/mm models).

End of stroke confirmation

When the signal is applied continuously in the same direction, the actuator turns on every 2 hours and drives in the signal direction for approximately 90 seconds (13 sec/mm models) and approximately 60 seconds (8 sec/mm models) to confirm the end of stroke position.

Table 2: Actuator stem direction

Input	Direction	
Brown wire energised	↓	Actuator stem extends
Orange wire energised	↑	Actuator stem retracts

24 VAC/VDC Proportional Model with fixed stroke

VA-7482-xx01 Factory Stroke configured series (jumper setting)

When the power is applied, the actuator self-calibrates performing an auto-zero detection cycle. The actuator moves the stem down for a complete mechanical valve stroke until no changes are detected. Once the auto-zero is detected the actuator moves the stem accordingly with the input signal, within the value of the electrical stroke as per jumper setting.

When the input signal increases (eg. from 0V to 10V) the actuator stem extends if the actuator is configured as Direct Action (DA) or retracts if the actuator is configured as Reverse Action (RA).

When the input signal decreases (eg. from 10V to 0V) the actuator stem retracts if the actuator is configured as Direct Action (DA) or extends if the actuator is configured as Reverse Action (RA) (see Table 3).

24 VAC/VDC Proportional Model with auto stroke capability

VA-7482/3/4-8x01 and VA-7482/3/4-9x01 Auto Stroke detection series

IMPORTANT: Auto Stroke detection is suitable for valves with minimum 2 kg spring preloading.

When the power is applied, the actuator performs the auto stroke detection cycle to detect the real valve stroke. The actuator moves the stem down for a complete mechanical valve stroke until no stroke changes are detected. Once the lower valve stem position is detected, the actuator moves the spindle up until it is fully retracted while the microprocessor counts and stores the full stroke of the actuator. Then, the actuator drives the spindle down in order to detect the upper valve stem position, being able to calculate the real stroke subtracting the gap value. As soon as the spindle of the actuator touches the valve stem, the actuator stops the auto stroke detection cycle (red LED blinking) and starts the operational mode (green LED blinking).

When the input signal increases (eg. from 0V to 10V) the actuator stem extends if the actuator is configured as Direct Action (DA) or retracts if the actuator is configured as Reverse Action (RA).

When the input signal decreases (eg. from 10V to 0V) the actuator stem retracts if the actuator is configured as Direct Action (DA) or extends if the actuator is configured as Reverse Action (RA) (see Table 4).

End of stroke confirmation

For VA-7482-0011 model only:

When the input signal is at 0 or 100%, the actuator turns on every 2 hours and drives in the signal direction for approximately 90 seconds (13 sec/mm models) and approximately 60 seconds (8 sec/mm models) to confirm the end of stroke position.

For VA-7482-xx01 models:

When the input signal is at 100% the actuator turns on every 2 hours and drives in the signal direction for approximately 60 seconds to confirm the end of stroke position.

Table 3: Actuator stem direction

Action	Input	Direction	
Direct acting	0-10 VDC	↓	Actuator stem extends
	10-0 VDC	↑	Actuator stem retracts
Reverse acting	0-10 VDC	↑	Actuator stem retracts
	10-0 VDC	↓	Actuator stem extends

Note: The actuator will perform the auto stroke detection cycle every time it is powered off/powerd on.

End of stroke confirmation

For VA-7482-8x01 and VA-7482-9x01 models:

When the input signal drives the actuator to completely extend the spindle for 2 hours, the actuator turns on the motor and drives the spindle in accordance with the signal for approximately 60 sec. to confirm the end of the stroke position.

For VA-7483/4-8x01 and VA-7483/4-9x01 models:

When the input signal drives the actuator to completely extend the spindle for 2 hours, the actuator turns on the motor and drives the spindle back for a short distance and then towards the end-stroke until stall is detected to confirm the end of the stroke position.

Table 4: Actuator stem direction

Action	Input	Direction	
Direct acting	0-10 VDC	↓	Actuator stem extends
	10-0 VDC	↑	Actuator stem retracts
Reverse acting	0-10 VDC	↑	Actuator stem retracts
	10-0 VDC	↓	Actuator stem extends

24 VAC/VDC Proportional Model with 0-10 VDC feedback output (VA-7483 and VA-7484)

Position feedback

The position feedback signal is for monitoring the actuator stroke position. It feeds information internally to the positioner and a 0-10 VDC signal can supply an external supervisory system. See *Table 5* for correspondence between control signal and feedback output.

Table 5: Positive feedback signal

Input signal range	Feedback output range
0-10V	0-10V
2-10V	0-10V
0-20 mA	0-10V
4-20 mA	0-10V
Custom Range	0-10V

24 VAC/VDC Proportional Model with 0-10 VDC feedback output and electric fail safe (VA-7484)

Electrical fail safe

The actuator is equipped with a super capacitor, which, in case of power failure, will drive the actuator and valve to the pre-defined safety position either open or closed. When the power supply is restored, the actuator will be available for normal operation after the super capacitor is fully charged within 150 sec. After the super capacitor is charged a new auto stroke detection routine is performed.

Table 6: Electric fail safe direction

Setting	Direction	
EFSD (Electric Fail Safe Down)	↓	Actuator stem extends in case of power failure
EFSU (Electric Fail Safe Up)	↑	Actuator stem retracts in case of power failure





The electrical safety technology has been designed for a long life service with 5000 full charges guaranteed.

Operating status indication

24 VAC/230 VAC Floating Model

The floating models are equipped with a green LED which provides information about the operating status.







Table 7: LED status

OFF		No power supply
Green blinking		Moving to position
Green blinking		End stroke confirmation
Green steady on		End stroke reached

24 VAC/VDC Proportional Model

The proportional models are equipped with a bi-colour LED (green-red) which provides information about the operating status and diagnostics.







Table 8: LED status and diagnostics

OFF		No power supply
Green blinking		Moving to position
Green blinking		End stroke confirmation
Green steady on		Position reached
Red blinking		Cycle
Red steady on		4-20 mA or 2-10 VDC signal lost

24 VAC/VDC Proportional Model with feedback

The proportional models are equipped with a bi-colour LED (green-red) which provides information about the operating status and diagnostics.











Table 9: LED status and diagnostics

OFF		No power supply
Green blinking		Moving to position
Green steady on		Position reached
Red blinking slow		Initialization / Auto stroke detection
Red blinking fast		Sticking Error
Red steady on		4-20 mA or 2-10 VDC signal lost

24 VAC/VDC Proportional Model with feedback and electric fail safe

The proportional models are equipped with a RGB LED which provides information about the operating status and diagnostics.

Table 10: RGB status and diagnostics

OFF		No power supply
RGB blinking		Not configured
Green blinking		Moving to position
Green steady on		Position reached
Red blinking slow		Initialization / Auto stroke detection
Red blinking fast		Sticking error
Red steady on		4-20 mA or 2-10 VDC signal lost
Blue blinking slow		Super capacitor acting, Fail Safe on action
Blue blinking fast		Super capacitor close to end of life. Recommended actuator replacement
Blue steady on		Super capacitor recharging

■ Mounting instructions

When mounting the actuator on terminal unit valves, follow these instructions:

- Never use the actuator as a mounting lever.
- It is recommended that the valves be mounted upright or at angles not greater than 90° in an easily accessible location.

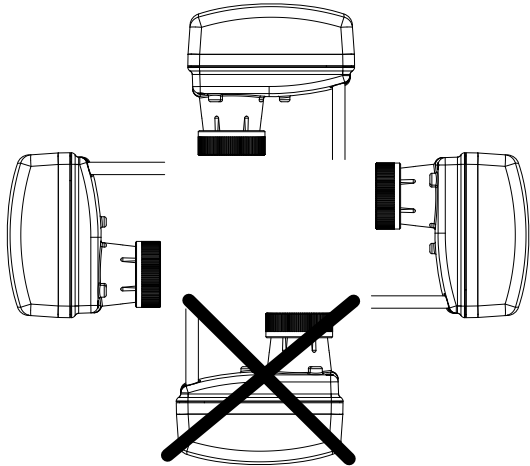

Figure 2: Mounting position

- Do not mount the actuator upside down to avoid dripping water, as this could enter the housing and damage the mechanism or motor.
- Do not cover with insulating material.
- Hand tighten only. Do not over tighten. When mounting the actuator on the valve, only hand tighten the brass threaded coupling. Using a wrench to tighten the coupling will damage the actuator, cause it to fail, and will void the warranty. Position the actuator on the valve before tightening by hand.

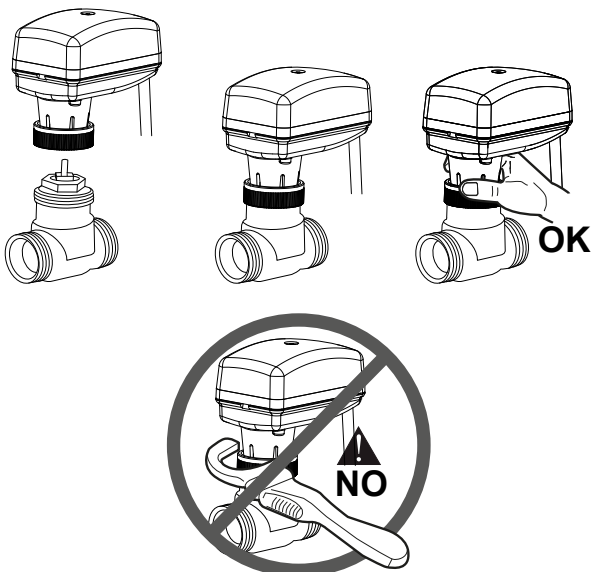

Figure 3: Hand tighten only

- Never grab the actuator and forcibly turn it. To reposition the actuator on the valve, loosen the coupling, reposition the actuator and then retighten the brass coupling by hand.
- Sufficient clearance must be allowed for actuator removal (see dimensions below).

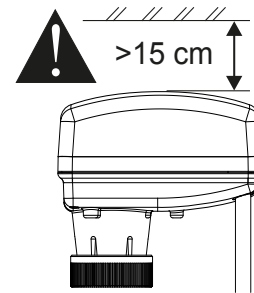

Figure 4: Clearance

- Check to be sure the actuator spindle is in its full retracted position as received.

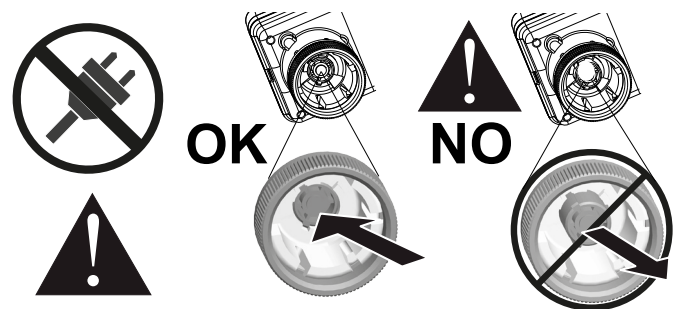

Figure 5: Spindle retracted

- Do not connect the power supply before mounting the actuator on the valve.

■ Removing actuator from valve

IMPORTANT: Do not remove the actuator without switching off its power supply

In some situations, you may need to mount the actuator to a new valve with different closing dimensions. For example, if a Pressure Independent Control Valve (PICV) needs to be repositioned with a new stroke setting to suit new flow requirements, or a new valve with different closing dimensions replaces the old one. To safely mount the actuator to the new valve, complete the following steps:

24VAC & 230 VAC Floating models, VA-7482-xx01 Factory Stroke configured Series (Jumper setting) and VA-7482/3-8x01 and VA-7482/3-9x01 Auto Stroke detection series:

1. Set the input signal to the actuator, to move the valve stem to the max extended position (the actuator spindle will move to the retracted position)
2. Switch off the power supply on the actuator
3. Remove the actuator
4. Check that the actuator spindle is in the retracted position (see Figure 5, further details on page 10)

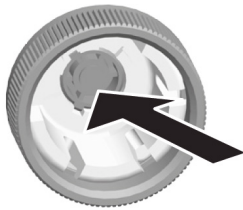

Figure 6: Spindle retracted

5. Set the new valve position (for PICV) or replace by the new valve
6. Refit the actuator to valve
7. Switch on the power supply on the actuator
8. The actuator will perform the standard or auto stroke detection cycle again to reposition itself based on the new valve setting.

VA-7484-8x01 and VA-7484-9x01 Auto Stroke detection series:

If the actuator is set to **Electrical Fail Safe Up** :

1. Set the input signal to the actuator, to move the valve stem to the max extended position (the actuator spindle will move to the retracted position)
2. Switch off the power supply on the actuator
3. Remove the actuator

4. Check that the actuator spindle is in the retracted position (see Figure 6, further details on page 10)



Figure 7: Spindle retracted

5. Set the new valve position (for PICV)
6. Refit the actuator to valve
7. Switch on the power supply on the actuator
8. The actuator will perform the auto stroke detection cycle again to re-position itself based on the new valve setting.

If the actuator is set to **Electrical Fail Safe Down**:

1. Set the input signal to the actuator, to move the valve stem to the max extended position (the actuator spindle will move to the retracted position)
2. Switch off the power supply on the actuator
3. Connect the configuration tool to the actuator and select **Safe Unmounting** option
4. Remove the actuator
5. Check that the actuator spindle is in the retracted position (see Figure 7 below, further details on page 10)



Figure 8: Spindle retracted

4. Set the new valve position (for PICV) or replace by the new valve
5. Refit the actuator to valve
6. Switch on the power supply on the actuator
7. The actuator will perform the auto stroke detection cycle again to reposition itself based on the new valve setting.

■ Wiring instructions



WARNING

When servicing make sure that:

- the electric supply to the actuator is switched off to avoid possible damage to the equipment, personal injury or shock.
- you do not touch or attempt to connect or disconnect wires when electric power is on.
- all wiring should conform to local codes and must be carried out by authorized personnel only.
- keep high and low voltage wiring separated.
- when using multi-stranded wire apply a cable ferrule to the cable end.
- make sure that the line power supply is in accordance with the power supply specified on the device.
- check all wiring connections before applying power to the system.

Contact with components carrying hazardous voltage can cause electric shock and may result in severe injury or death.

Short-circuited or improper connected wires may result in permanent damage to the equipment. Not adhering to these operational instructions could cause injury or damage the equipment.

Wiring Diagrams

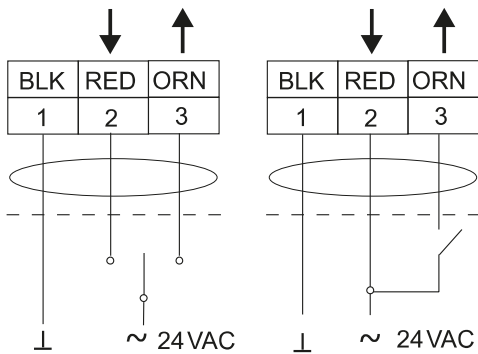

Figure 9: 24 VAC Floating Model

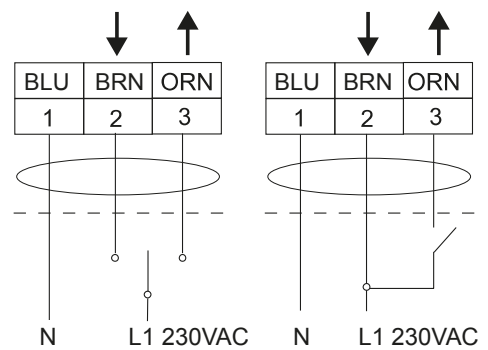

Figure 10: 230 VAC Floating Model

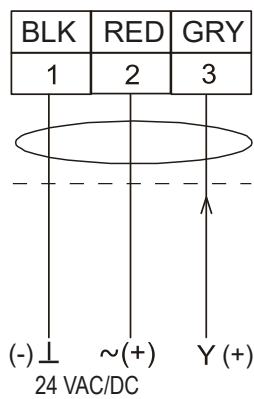

Figure 11: 24 VAC/VDC Proportional Model

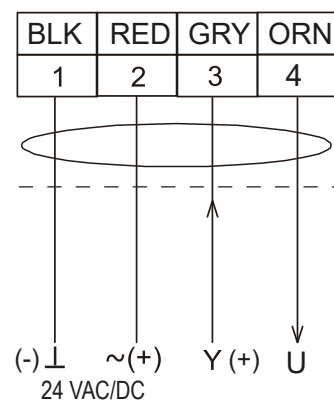

Figure 12: 24 VAC/VDC Proportional Model with feedback and Proportional Model with feedback and electric fail safe

Dip switch settings (Proportional Models only)

VA-7482 Models

These proportional models have a 6 dip switches which allow the user to field configure the actuator. The actuator is factory released with all the dip switches in OFF position.

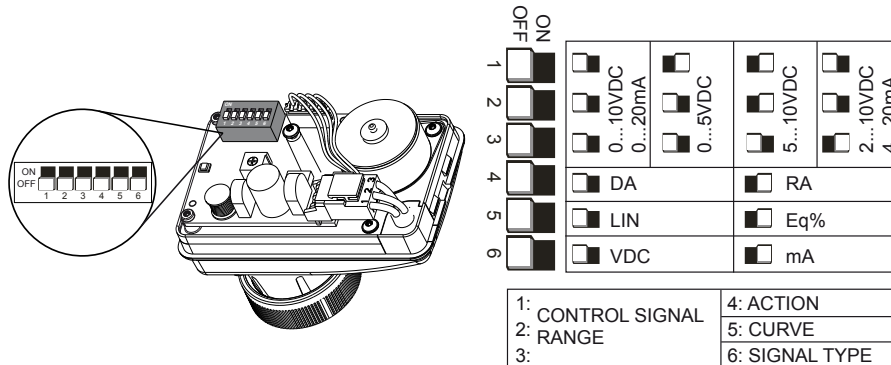

Figure 13: VA-7482 dip switches

VA-7483 Models

These proportional models have 8 dip switches which allow the user to field configure the actuator.

The actuator is factory released with all the dip switches in OFF position.

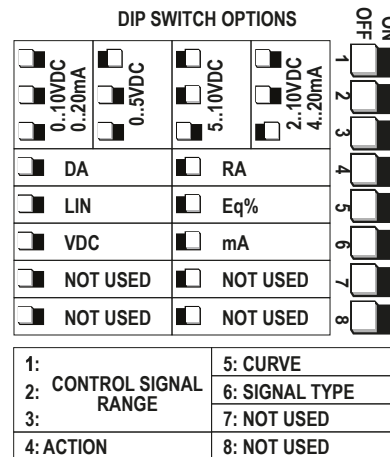

Figure 14: VA-7483 dip switches

Dip switch 1, 2, 3, 6

The dip switches 1, 2, and 3 allow the user to change the analog input ranges. To switch from voltage analog input to current analog input the dip switch 6 has to be set accordingly.

Dip switch 4

The dip switch 4 allows the user to change the action of the actuator in relation of the analog input.

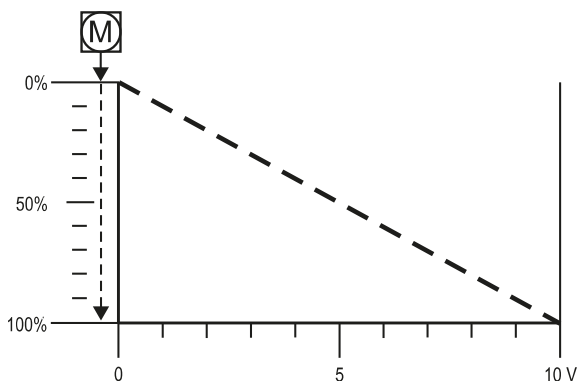

Figure 15: The dip switch 4 OFF (Direct Acting – DA)
When the signal increases the actuator stem extends.

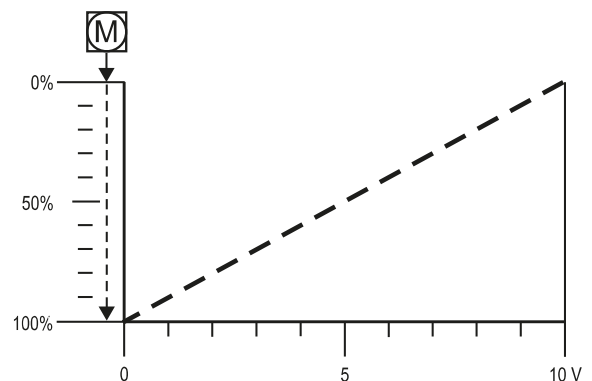

Figure 16: The dip switch 4 ON (Reversing Acting – RA)
When the signal increases the actuator stem retracts.

Dip switch 5

Use the dip switch 5 to change the control characteristics of the actuator in order to obtain a combination of valve and actuator linear or almost equal percentage.

Dip switch 5 OFF (linear)

Use this option with linear or equal percentage control valves.

Dip switch 5 ON (almost equal percentage)

Use this option with quick opening or on/off control valves.

■ Configuration tool (VA-748X-CONF)

VA-7484 Models

The user can field configure these proportional model actuators through an external user-friendly configuration tool (VA-748X-CONF). The actuator is released with the below factory settings (factory settings in **bold**).

FACTORY SETTINGS		
Y(+) [***] Analog Input	0-10 VDC 2-10 VDC 0-5 VDC 5-10 VDC	0-20 mA 4-20 mA
Action	DA	RA
Curve	LIN	Eq%
Fail Safe Action	EFSU (Electrical Fail Safe Down) ↓	EFSU (Electrical Fail Safe Up) ↑

Follow these steps to connect the configurator tool to the actuator:

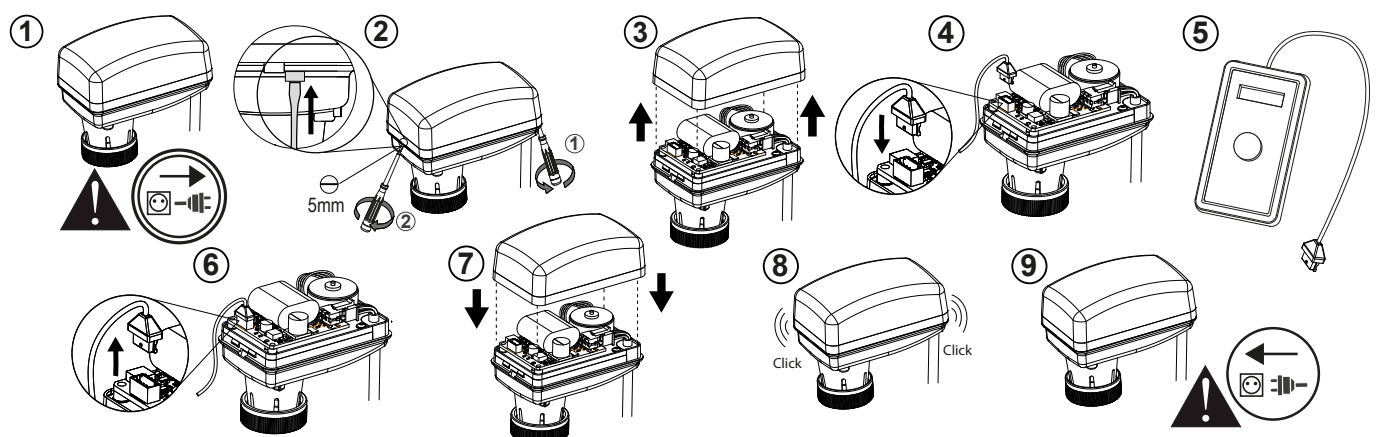

Figure 17: Configurator connection instructions

Power-on

To power on, connect the configuration tool to the actuator’s dedicated port and press the encoder button for more than 2 seconds.

Note: The configuration tool will automatically power off after a few seconds if it does not detect any connected actuator.

Configuration process

Use the rotary encoder to navigate through the menu. Rotate clockwise to show the next item on the display, and counterclockwise to show the previous one.

To select an item, press the encoder button for more than 2 seconds. To return to the previous level menu, press the encoder button for more than 4 seconds.

The first-level menu contains the following options:

1. **Load Configuration:** Shows the last saved configuration on the display and uploads it into the actuator
2. **Set Configuration:** Shows all configurable parameters
3. **Safe Unmounting:** Select this option to remove the actuator safely from the valve. The actuator will fully retract the spindle.

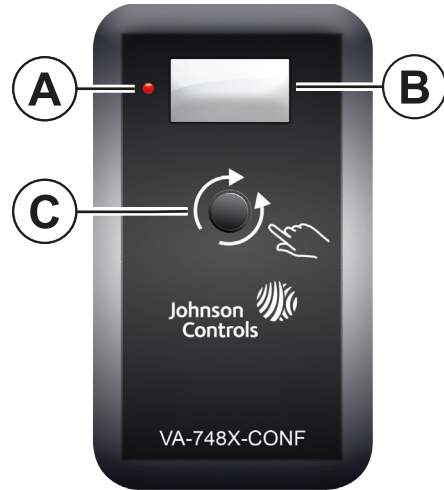

Figure 18: Configuration tool

Table 17: Configuration tool

Callout	Component
A	LED status
B	Display
C	Rotary Encoder button

Set Configuration process

When option **Set Configuration** is selected, all configurable parameters are shown. Select a specific parameter to go through the different available parameter values.

After selecting a new parameter value the configuration tool will automatically go back to the parameter list. In order to go back to the parameter list without changing the current value press the encoder button for more than 4 seconds.

The parameters and their values are as below:

1. **Control signal type**
 - a. Voltage
 - b. Current
2. **Control signal span**
 - a. 0-10V (if “Voltage” setting chosen)
 - b. 2-10V (if “Voltage” setting chosen)
 - c. 0-5V (if “Voltage” setting chosen)
 - d. 5-10V (if “Voltage” setting chosen)
 - e. 0-20 mA (if “Current” setting chosen)
 - f. 4-20 mA (if “Current” setting chosen)
3. **Action type**
 - a. DA (Direct Action)
 - b. RA (Reverse Action)
4. **Curve type**
 - a. Linear
 - b. EQ%
5. **Fail Safe action**
 - a. Electrical Fail Safe Up
 - b. Electrical Fail Safe Down
6. **Save Configuration**
 - a. Yes
 - b. No
7. **Load Configuration**

Safe unmounting procedure

To safely remove the actuator from the valve when it is set with Electrical Fail Safe Down (EFSD) configuration, complete the following step.

Note: The configuration tool must be connected to the actuator following the dedicated procedure.

In the first level menu choose the **Safe Unmounting** option. This will cause the actuator to fully retract the spindle, allowing the safe removal of the actuator from the valve. When performing this operation the actuator's settings will not be changed.

WARNING: Do not remove an actuator with Electrical Fail Safe Down (EFSD) configuration from valve without performing the safe unmounting procedure.

Electrical actuator stroke and closing dimensions

All the Proportional models with factory stroke configuration option have 1 jumper with which the user can change the electrical stroke.

The actuators are delivered with the following factory settings (see table below).

Note: All Proportional models with Auto stroke detection do not require the jumper as they can detect the real valve stroke automatically.

All the Floating models have fixed stroke and the jumper option is not available.

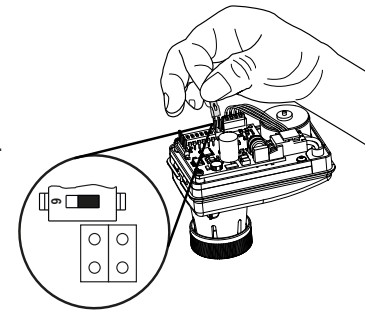
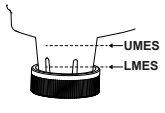
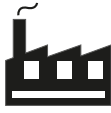









Figure 19: Stroke options

		Product codes	Note	
UMES 16.3 mm LMES 10.0 mm		PDTC	Proportional model VA-7482-0011 (suitable for the VG5000 and VG4000) For proportional actuator, suitable for the VG5000 or VG4000, the jumper allows the user to set push down to close (PDTC) or push down to open (PDTO) function. The actuator is factory set for use with 2-way Push Down to Close (PDTC) VG4200 and VG5200 valves. For 2-way Push Down To Open (PDTO) VG4400 and VG5400 valve applications set the valve port selection jumper to PDTO. For 3-way VG4800 and VG5800 valve applications set the jumper to the valve port type that corresponds to the service port of the valve.	
		PDTO		
		3.2 mm	VA-7482-1x01	
		4.3 mm	VA-7482-2x01	
		6.0 mm	VA-7482-3x01	
	Auto Stroke Detection		VA-7482-8x01	Proportional model VA-7482-x001 / VA-7482-8x01 / VA-7482-9x01 / VA-7483-8201 / VA-7483-9201 / VA-7484-8001 / VA-7484-9001 The proportional actuator VA-7482-x001 series is suitable for different terminal units in the market as shown on the <i>Valve compatibility</i> table, pages 4 and 5.
			VA-7482-8002-RA	
			VA-7483-8201	
			VA-7484-8001	
	UMES 14.5 mm LMES 8.2 mm		2.5 mm	
		5 mm	VA-7482-6x01	
		5.5 mm	VA-7482-7x01	
Auto Stroke Detection			VA-7482-9x01	
			VA-7482-9002-RA	
			VA-7483-9201	
			VA-7484-9001	
UMES 16.3 mm LMES 10.0 mm		---	VA-7480-0xxx VA-7481-0xxx	Floating model VA-7480-0xxx / VA-7481-0xxx / VA-7480-4xxx / VA-7481-4003 All the floating models have fixed stroke and the jumper option is not available.
UMES 14.5 mm LMES 8.2 mm	---	VA-7480-4xxx VA-7481-4003		

Note: UMES: Upper Mechanical End Stroke / LMES: Lower Mechanical End Stroke

■ Dimensions

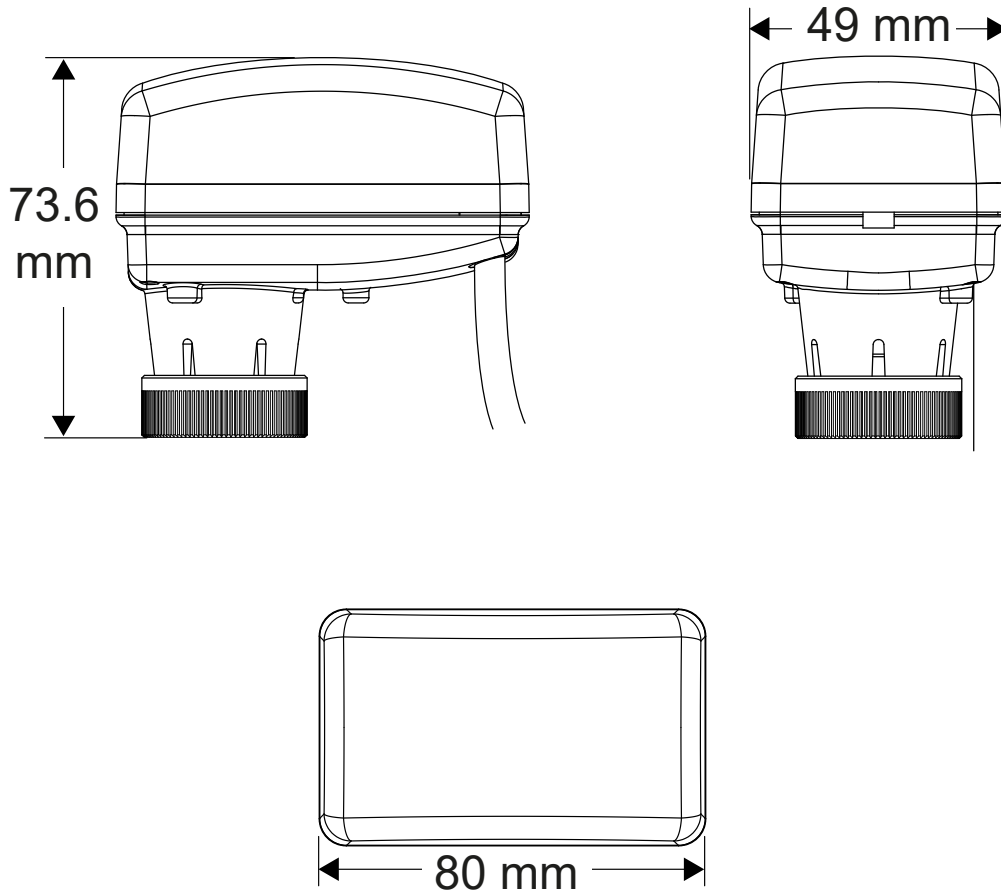

Figure 20: Actuator dimensions

Technical specifications

Actuator models	VA-7480-x0x1	VA-7481-00x1	VA-7481-x0x3	VA-7481-x0x3	VA-7482-x002-RA	VA-7482-x0x1	VA-7483-x201	VA-7484-x001
Action control	Floating or PAT				Proportional			
Supply voltage (50/60Hz)	24 VAC ±15%		230 VAC ±10%		24 VAC ±15% 24 VDC ±15%			
Feedback	<i>Signal</i>				---			
	<i>Rating</i>				---			
					0-10 VDC ±5%			
					max 2 mA at 0-10 VDC			
Input impedance	<i>Voltage</i>				---			
	<i>Current</i>				---			
					>100 kΩ			
					500 Ω			
Power consumption	<i>Apparent (Running)</i>		2.5 VA		6.0 VA		2.5 VA	
	<i>Active (Running)</i>		1.5 W		2.2 W		1.5 W	
	<i>Apparent (Charging)</i>		---		---		5 VA	
	<i>Active (Charging)</i>		---		---		3W	
Max stroke	6 mm							
Running time	13 sec/mm	8 sec/mm	13 sec/mm	8 sec/mm				
Charging time	---							150 sec
Protection	IP54		IP43		IP54			
Material	<i>Cover</i>							
	ABS + PC							
	<i>Yoke</i>							
	PA66 – Glass Mineral filled (30% total)							
	<i>Thread nut</i>							
	Brass CuZn40Pb2							
Housing colour	White semitransparent							
Thread nut connection	See "Ordering Codes"							
Ambient operating condition	0°C to 50°C, 10 to 90 RH%							
Ambient storage condition	-20°C to 65°C, 5 to 95 RH%							
Max. fluid temperature	95 °C							
Electrical connections	1.5 m cable length (3 x 0.35 mm ²)		1.5 m cable length (3 x 0.75 mm ²)		1.5m CMP	1.5 m cable length (3 x 0.35 mm ²)	2 m cable length (4 x 0.35 mm ²)	1.5 m cable length (4 x 0.35 mm ²)
Operating status indications	LED							
Audible noise rating	< 30 dB(A)							
Life	250,000 cycles (standard models) / 150,000 cycles (auto stroke models)							
Shipping weight	0.2 Kg							



Johnson Controls declares that this product is in compliance with the essential requirements and other relevant provisions of the EMC Directive and Low Voltage Directive.

* VA-7482-x002-RA Is Tested per UL2043. Suitable for Use in Other Environmental Air Space (Plenums) in Accordance with Section 300.22 (C) of the National Electrical Code. UL 60730-1 Listed Type 2 Enclosure, File E194024 XAPX XAPX7

Single point of contact

APAC

JOHNSON CONTROLS
C/O CONTROLS PRODUCT MANAGEMENT
NO. 32 CHANGJIJANG RD NEW DISTRICT
WUXI JIANGSU PROVINCE 214028 - CHINA

Europe

JOHNSON CONTROLS
WESTENDHOF 3
45143 ESSEN
GERMANY

NA/SA

JOHNSON CONTROLS
507 E MICHIGAN ST
MILWAUKEE WI 53202
USA

Contact information

Contact your local branch office: www.johnsoncontrols.com/locations

Contact Johnson Controls: www.johnsoncontrols.com/contact-us



Building Technologies & Solutions
Headquarters: Milwaukee, Wisconsin, USA
Branch Offices: Principal Cities World-wide
© Copyright 2021 Johnson Controls.
All specifications and other information shown were current as of document revision and are subject to change without notice.